S620H HYBRID

SMART Series



Product parameters

Optical system

Source: Philips MSD Platinum 19 R LL, 420W

Fixture CT : 6700K

Lamp life expectancy : 5000 hrs

Movement

Pan: 540 ° /630 ° optional(16 bit)

Tilt: 270 ° (16 bit)

Auto pan/tilt repositioning

Color system

CMY color mixing



1 color wheel : 14 dichroic filters + open, color effect, indexable, split color effect, rainbow effect

Gobo system

1 Rotating gobo wheel:8 interchangeable gobos + open. Gobo OD: 16.3mm

1 Static gobo wheel:14 gobos + open

Effect

Motorized focus

Zoom range: beam mode:2.3 ° -28 ° ; spot mode: 5.5 ° -42 ° ; wash mode: 11 ° -40 °

Auto focus

2 Rotating prism: 4-facet linear prism + 8-facet circular prism, indexable, 16 prism Macros

Frost

Dimming: 0-100% linear dimming

Strobe: electronic, variable from 1-25Hz or pulse

Protection rating

IP20

Display

Display: optional with rechargeable battery, locked automatically after standby for 15 seconds

Pan/tilt disengage (hold Left and Right arrow buttons), support to complete the reset detection in the flight case

Software

Upgrade with DMX

Remote reset DMX address and fixture by DMX

Run time of fixture and light source

2 Control channel modes: 25/36 CH

Control



Input signal isolation
Auto thermal protection circuit
RDM protocol

Electric parameter
AC200-240V, 50/60Hz
Power consumption: 600W

Dimension and weight
Product dimension: 395x270x616.5mm
Packing dimension (carton): 730x475x385mm
Net weight: 20.5 kg
Gross weight (carton): 25.2 kg

Colours/ Gobos

COLOR WHEEL: 

ROTATING GOBO WHEEL: 

STATIC GOBO WHEEL: 

Dimensions

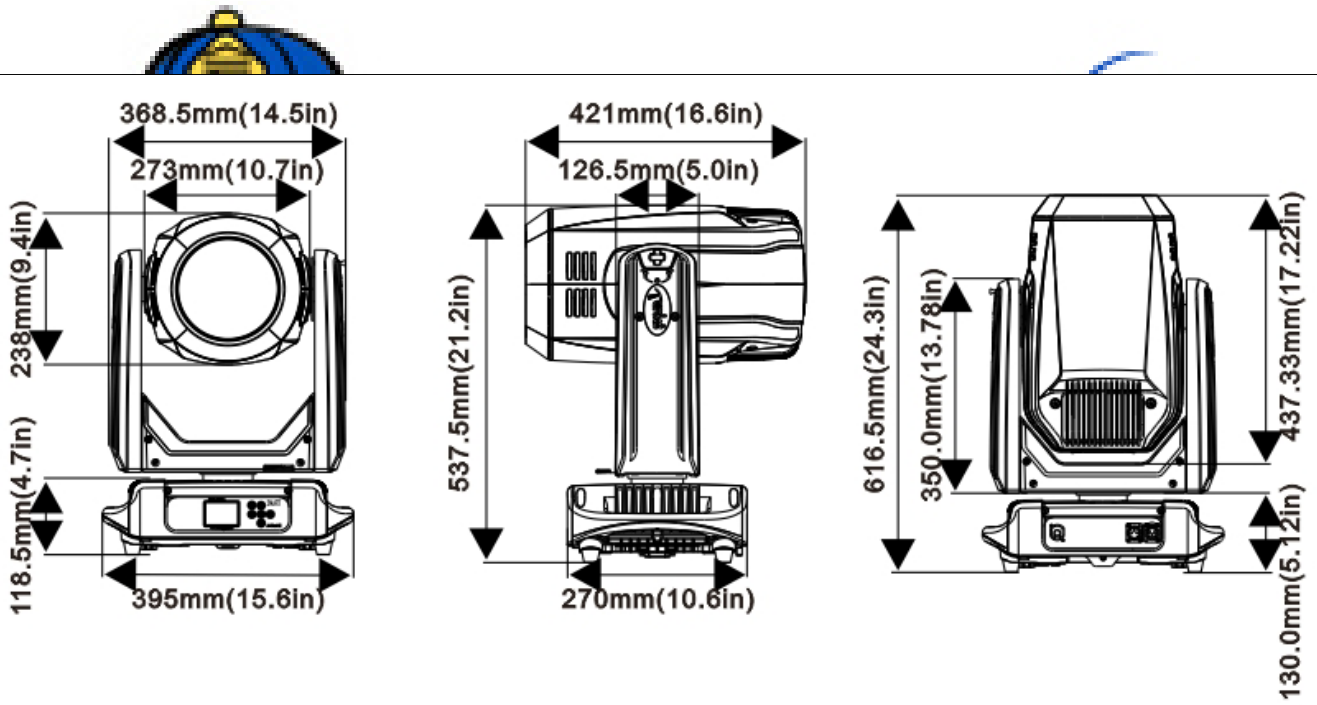

Photometrics

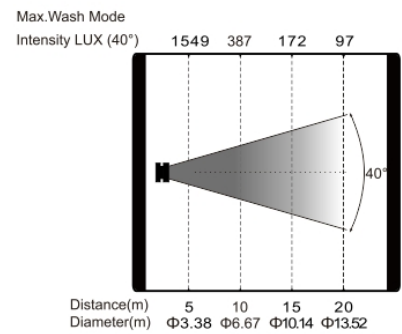
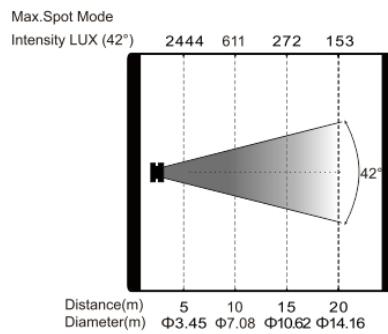
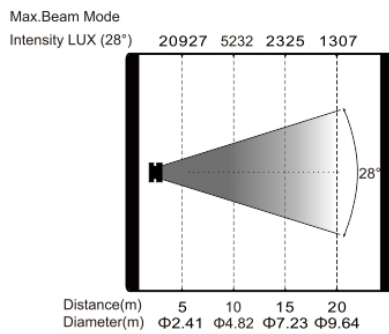
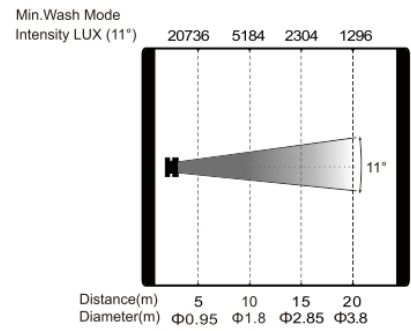
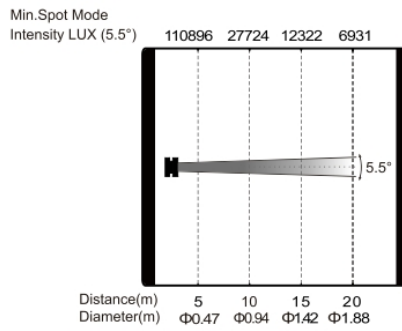
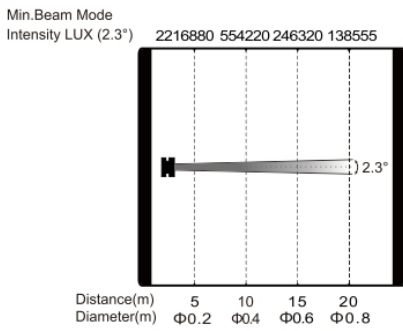



Errors and omissions are possible. All specifications are subject for change without prior notice.